



# Lumped Loudspeaker Driver Using a Lumped Mechanical System

## Introduction

---

This is a model of a moving-coil loudspeaker where a lumped parameter analogy represents the behavior of the electrical and mechanical speaker components. This lumped model is coupled to a 2D axisymmetric pressure acoustics model describing the surrounding air domain.

This example illustrates an alternative way of modeling mechanical components (mass, spring, and damper) using the Lumped Mechanical System interface in a lumped loudspeaker driver model. More information regarding the theory and a model setup can be found in the model *Lumped Loudspeaker Driver* in the Acoustics Module Application Library.

---

**Note:** This model requires the Acoustics Module, the AC/DC Module, and the Multibody Dynamics Module.

---

## Model Definition

---

A schematic representation of a moving coil loudspeaker is given in [Figure 1](#). The figure shows a cross section of a loudspeaker. The speaker driver is placed in an infinite baffle with free space in front and on the back of the speaker. The speaker cone consists of the outer suspension, the diaphragm, and a dust cap (not marked in the figure).

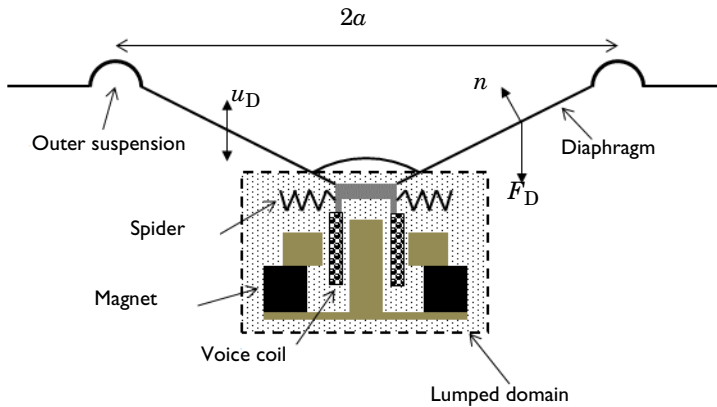

*Figure 1: Schematic representation of a moving coil speaker unit.*

The mechanical and electrical components of the speaker that are lumped are shown inside the dotted box. On the electrical side it includes the voice-coil and magnetic system (permanent magnet and pole pieces), and on the mechanical side it includes the moving mass of the voice coil and speaker cone, the spring effect of the spider and outer suspension, as well as possible losses due to damping in these suspensions.

### LUMPED REPRESENTATION OF ELECTRICAL AND MECHANICAL COMPONENTS

The lumped or circuit representation for the electrical and mechanical parts of the system sketched in Figure 1 is shown in Figure 2. The upper figure represents the voice coil electrical system and the lower figure represents the lumped mechanical system of the speaker cone, suspensions, and mass of the voice coil. In both figures the node numbers are also shown — they are very useful when setting up the circuit model in COMSOL.

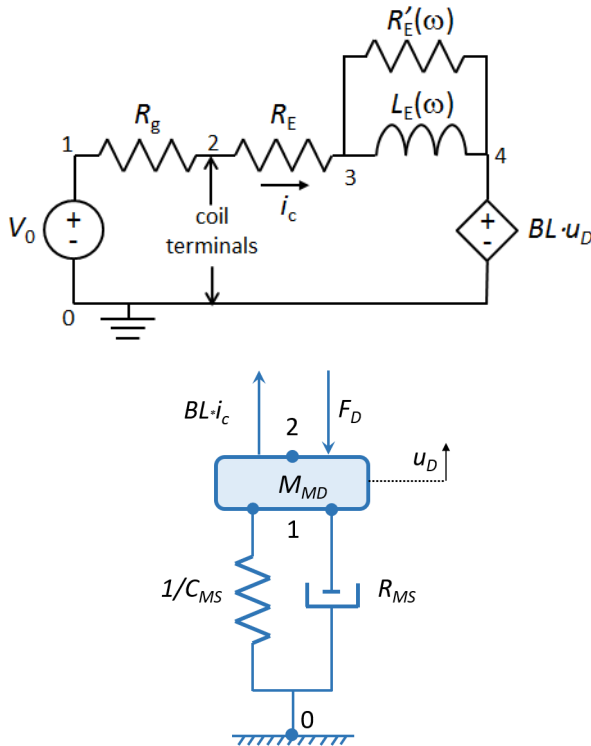

Figure 2: The lumped (circuit) representation for the electrical (top) and mechanical (bottom) components of the speaker driver.

In [Figure 2](#) (top), the external voltage source is denoted by  $V_0$  and the generator output resistance is  $R_g$ , in this model  $R_g = 0 \Omega$ . The voice coil resistance is  $R_E$ , and the voice coil inductance is  $L_E(\omega)$ , which is frequency dependent. The losses in the magnetic circuit are modeled through the frequency dependent resistance  $R'_E(\omega)$ . The current controlled voltage source  $BL \cdot u_D$ , represents the back induced electromagnetic voltage generated when the voice coil (of length  $L$ ) moves with velocity  $u_D$  in the magnetic field  $B$ . Here,  $BL$  is the product of the magnetic field strength and the voice coil length  $L$  (see also [Ref. 2](#) on how this can be modeled). In the electrical circuit, the current is denoted  $i_c$ .

The mechanical system given in [Figure 2](#) (bottom) has the following components:

- Mass ( $M_{MD}$ ) representing the mass of voice coil and diaphragm assembly
- Spring ( $1/C_{MS}$ ) representing the stiffness of speaker suspensions (both spider and outer suspension)
- Damping ( $R_{MS}$ ) representing the possible losses in suspensions

The speaker diaphragm is subjected to the following forces acting in the axial direction:

- Lorentz force: The Lorentz force is given by  $BL \cdot i_c$  for a voice coil of length  $L$  with current  $i_c$ , where  $B$  is the magnetic flux density.
- Pressure force: The acoustic pressure force is given by

$$F_D = \int (\Delta p \cdot n_z) dA \quad (1)$$

where  $\Delta p$  is the pressure drop across the diaphragm and  $n_z$  is the axial component of the surface normal  $\mathbf{n}$  (see [Figure 1](#)). This expression gives the couplings from the acoustic finite element model to the lumped mechanical model. On the other hand, the coupling from the lumped mechanical model to the finite element model comes from specifying the acceleration on the surface of the diaphragm.

For more details about the model including small signal parameters, and finite element modeling refer to [Ref. 3](#).

## *Results and Discussion*

---

The generated pressure field is shown in [Figure 3](#) for 1 kHz and 5 kHz. This plot shows the directive characteristic of the speaker cone at increasing frequencies; this nature is discussed more at the end of this section when discussing the directivity plot in [Figure 7](#).

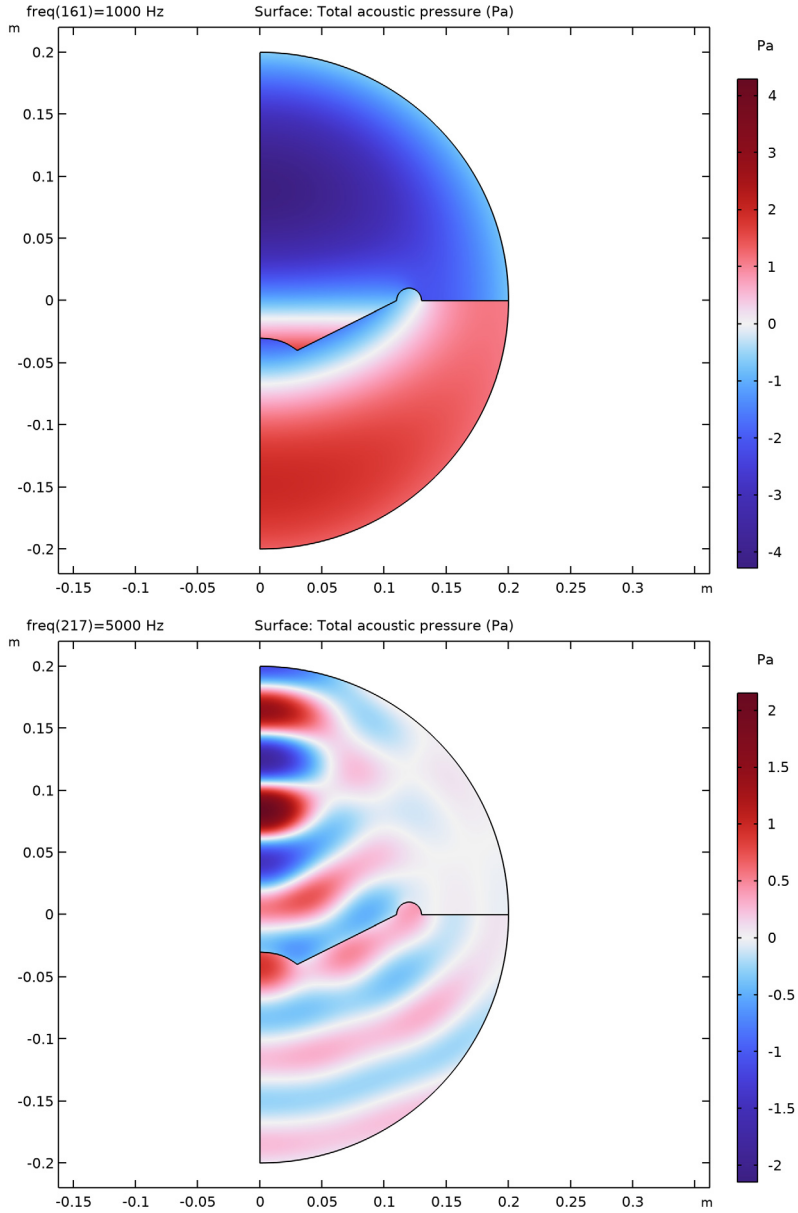

Figure 3: Acoustic pressure for a frequency of 1 kHz (top) and kHz (bottom).

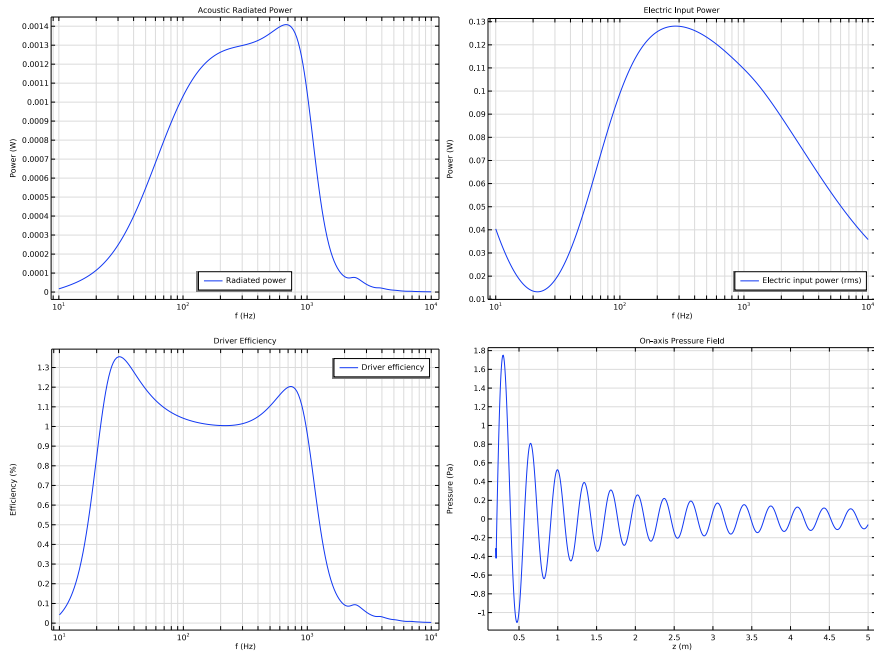
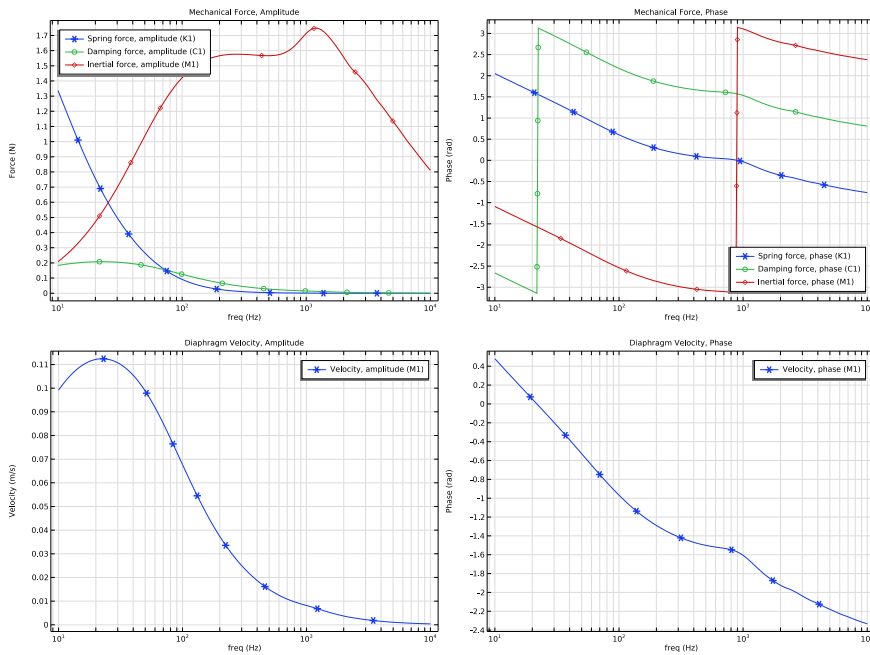

Figure 4: The frequency dependent acoustic radiated power (upper left), electric input power (upper right), efficiency (lower left), and on-axis pressure field (lower right).

The first two graphs in Figure 4 (upper left and upper right) represent the acoustically radiated power  $P_{AR}$  and the electric input power  $P_E$ .

The third (lower-left) graph of Figure 4 represents the driver efficiency given in percent (%), that is, the ratio of the acoustic radiated power and the input electric power.

The pressure field along the  $z$ -axis is shown in the last graph of Figure 4 from  $z = R_{air}$  to  $z = 5$  m, evaluated at a frequency of 1000 Hz. In the model, a *Parametric Curve 2D* is used to evaluate the exterior-field pressure outside the computational mesh.



*Figure 5: The frequency dependent mechanical force amplitude (upper left), corresponding phase (upper right), diaphragm velocity amplitude (lower left), and corresponding phase (lower right).*

In the top row of [Figure 5](#), the frequency variation of the mechanical forces in mass, spring, and damper components are shown. The left graph shows the force amplitude whereas on the right graph, the phase is plotted. It can be seen that the spring force is dominant at low frequencies whereas the inertial force starts to dominate at higher frequencies. In the bottom row of [Figure 5](#), the frequency variation of the amplitude and phase of the speaker cone axial velocity is shown.

The pressure and the sound pressure level evaluated at 1 m, using the dedicated radiation pattern plots, are shown in [Figure 6](#), here evaluated at 10 kHz. In the figure the  $0^\circ$  mark corresponds to the axial  $z$  direction. Both figures show a very strong directive pattern as expected at this high frequency.

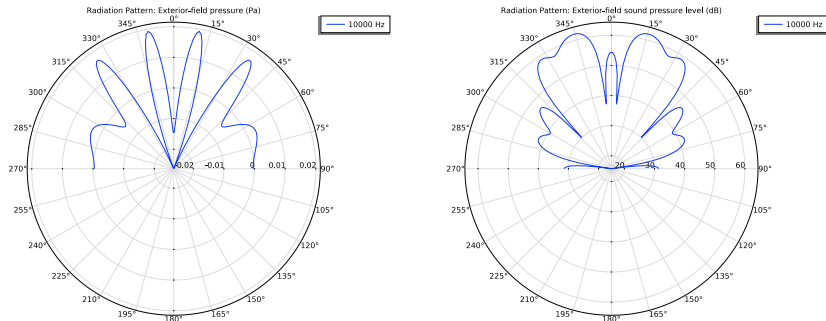

*Figure 6: Exterior-field pressure and sound pressure level evaluated at a distance of 1 m the half sphere in front of the speaker and at 10 kHz.*

In [Figure 7](#) (top), the radiated intensity is illustrated at 100 Hz. The color plot represents the magnitude of the intensity vector  $\mathbf{I}$ , the domain vector field represents the components of the intensity vector, and finally the vectors plotted on the edges represent the surface normals.

The final plot of this model is shown in [Figure 7](#) (bottom); it is a so-called directivity plot of the speaker unit. The plot represents a contour plot of the sound pressure level  $L_p$  evaluated along a half circle in front of the speaker as function of the angle and the frequency, that is,  $L_p(\theta, f)$ . The  $x$ -axis represents the angle and runs from  $-90^\circ$  to  $90^\circ$ . The  $y$ -axis is a logarithmic frequency axis running from  $10^1$  Hz to  $10^4$  Hz. The plot illustrates how the spatial response goes from a nearly omnidirectional constant value at the low frequencies, through a single lobe response at intermediate frequencies, and ends up as a complex directive pattern at high frequencies. This type of plot is very often used in industry, to characterize speakers and speaker units.



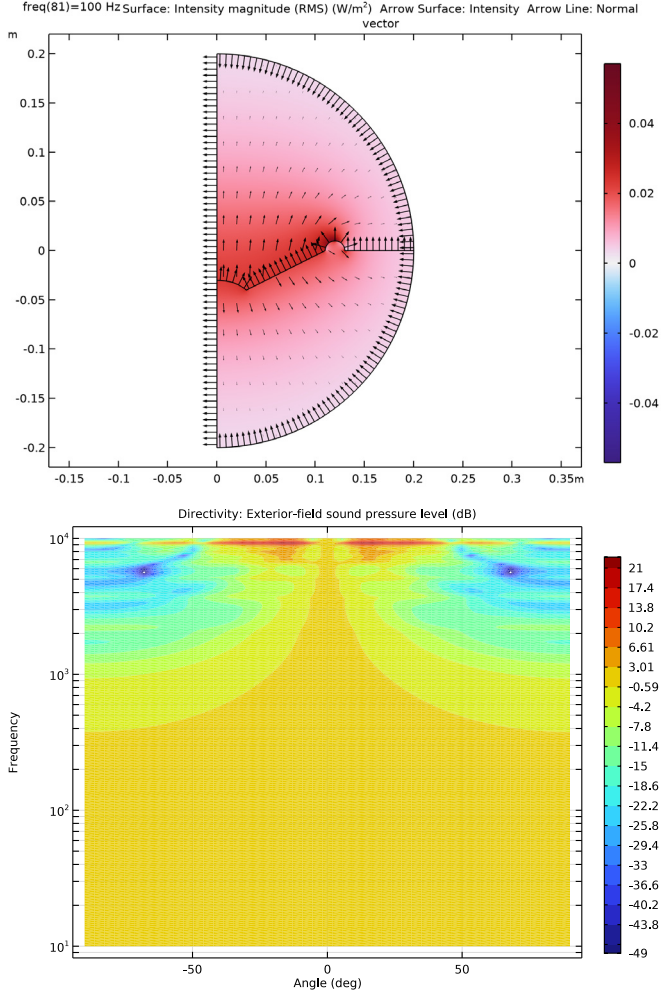

Figure 7: Top: intensity magnitude (color plot), intensity vector field (domain arrows), and surface normals (edge arrows) for 100 Hz. Bottom: directivity plot for the speaker. The x-axis is a scaled azimuthal angle that runs from  $-90^\circ$  to  $90^\circ$  and the y-axis is a logarithmic frequency axis that runs from 10 Hz to 10 kHz.

## References

1. W. Marshall Leach, Jr., *Introduction to Electroacoustics and Audio Amplifier Design*, Kendall Hunt, 2010.

2. *Loudspeaker Driver Model Documentation*, from the COMSOL Application Library.
3. *Lumped Loudspeaker Driver Model Documentation*, from the COMSOL Application Library.

---

**Application Library path:** Multibody\_Dynamics\_Module/Tutorials/  
lumped\_loudspeaker\_driver\_mechanical

---

### *Modeling Instructions*



---

From the **File** menu, choose **New**.

#### **NEW**

In the **New** window, click  **Model Wizard**.

#### **MODEL WIZARD**

- 1 In the **Model Wizard** window, click  **2D Axisymmetric**.
- 2 In the **Select Physics** tree, select **Acoustics > Pressure Acoustics > Pressure Acoustics, Frequency Domain (acpr)**.
- 3 Click **Add**.
- 4 In the **Select Physics** tree, select **AC/DC > Electrical Circuit (cir)**.
- 5 Click **Add**.
- 6 In the **Select Physics** tree, select **Structural Mechanics > Lumped Mechanical System (lms)**.
- 7 Click **Add**.
- 8 Click  **Study**.
- 9 In the **Select Study** tree, select **General Studies > Frequency Domain**.
- 10 Click  **Done**.

#### **GLOBAL DEFINITIONS**

Load small signal and geometric parameters from a file.





##### *Parameters 1*

- 1 In the **Model Builder** window, under **Global Definitions** click **Parameters 1**.
- 2 In the **Settings** window for **Parameters**, locate the **Parameters** section.
- 3 Click  **Load from File**.

- 4 Browse to the model's Application Libraries folder and double-click the file `lumped_loudspeaker_driver_mechanical_parameters.txt`.  
Import a simple 2D axisymmetric geometry of the speaker driver.

## GEOMETRY I



### *Import I (impl)*

- 1 In the **Geometry** toolbar, click  **Import**.
- 2 In the **Settings** window for **Import**, locate the **Source** section.
- 3 Click  **Browse**.
- 4 Browse to the model's Application Libraries folder and double-click the file `lumped_loudspeaker_driver_mechanical.mphbin`.
- 5 Click  **Import**.
- 6 In the **Geometry** toolbar, click  **Build All**.

Now, set up all the variables, selections, and component couplings under the **Definitions** node.

## DEFINITIONS

### *Model variables*

- 1 In the **Definitions** toolbar, click  **Local Variables**.
- 2 In the **Settings** window for **Variables**, type `Model variables` in the **Label** text field.
- 3 Locate the **Variables** section. Click  **Load from File**.
- 4 Browse to the model's Application Libraries folder and double-click the file `lumped_loudspeaker_driver_mechanical_variables.txt`.

### *Speaker*

- 1 In the **Definitions** toolbar, click  **Explicit**.
- 2 In the **Settings** window for **Explicit**, type `Speaker` in the **Label** text field.
- 3 Locate the **Input Entities** section. From the **Geometric entity level** list, choose **Boundary**.
- 4 Select Boundaries 6, 11, and 14 only.

### *Internal wall*

- 1 In the **Definitions** toolbar, click  **Explicit**.
- 2 In the **Settings** window for **Explicit**, type `Internal wall` in the **Label** text field.
- 3 Locate the **Input Entities** section. From the **Geometric entity level** list, choose **Boundary**.

4 Select Boundaries 7, 8, and 15 only.

#### *Integration 1 (intop1)*



- 1 In the **Definitions** toolbar, click  **Nonlocal Couplings** and choose **Integration**.
- 2 In the **Settings** window for **Integration**, locate the **Source Selection** section.
- 3 From the **Geometric entity level** list, choose **Boundary**.
- 4 From the **Selection** list, choose **Speaker**.
- 5 In the **Operator name** text field, type intop.

#### *Perfectly Matched Layer 1 (pml1)*

- 1 In the **Definitions** toolbar, click  **Perfectly Matched Layer**.
- 2 Select Domains 1 and 4 only.
- 3 In the **Settings** window for **Perfectly Matched Layer**, locate the **Scaling** section.
- 4 From the **Coordinate stretching type** list, choose **Rational**.
- 5 In the **PML scaling factor** text field, type 0.5.
- 6 In the **PML scaling curvature parameter** text field, type 5.

You have now changed the default settings for the perfectly matched layer (PML). The new settings will improve the performance of the PML at very low frequencies.

### **ADD MATERIAL**

- 1 In the **Materials** toolbar, click  **Add Material** to open the **Add Material** window.
- 2 Go to the **Add Material** window.
- 3 In the tree, select **Built-in > Air**.
- 4 Click the **Add to Component** button in the window toolbar.
- 5 In the **Materials** toolbar, click  **Add Material** to close the **Add Material** window.

Now, set up the physics and the boundary conditions for the model.

### **PRESSURE ACOUSTICS, FREQUENCY DOMAIN (ACPR)**

#### *Interior Sound Hard Boundary (Wall) 1*

- 1 In the **Physics** toolbar, click  **Boundaries** and choose **Interior Sound Hard Boundary (Wall)**.
- 2 In the **Settings** window for **Interior Sound Hard Boundary (Wall)**, locate the **Boundary Selection** section.
- 3 From the **Selection** list, choose **Internal wall**.

#### Interior Normal Acceleration I

- 1 In the **Physics** toolbar, click  **Boundaries** and choose **Interior Normal Acceleration**.
- 2 In the **Settings** window for **Interior Normal Acceleration**, locate the **Boundary Selection** section.
- 3 From the **Selection** list, choose **Speaker**.
- 4 Locate the **Interior Normal Acceleration** section. Specify the  $\mathbf{a}_0$  vector as

0	r
lms.M1.a	z

#### Exterior Field Calculation I

- 1 In the **Physics** toolbar, click  **Boundaries** and choose **Exterior Field Calculation**.
- 2 Select Boundary 12 only.
- 3 In the **Settings** window for **Exterior Field Calculation**, locate the **Exterior Field Calculation** section.
- 4 From the **Condition in the  $z = z_0$  plane** list, choose **Symmetric/Infinite sound hard boundary**.

Proceed to set up the electric circuit system and lumped mechanical system part of the model. When building this look at [Figure 2](#) for the references to the node numbers used in the model.

### ELECTRICAL CIRCUIT (CIR)

#### Voltage Source I (VI)

- 1 In the **Electrical Circuit** toolbar, click  **Voltage Source**.
- 2 In the **Settings** window for **Voltage Source**, locate the **Node Connections** section.
- 3 In the table, enter the following settings:

Label	Node names
p	1
n	0

- 4 Locate the **Device Parameters** section. In the  $v_{\text{src}}$  text field, type V0.

#### Resistor I (RI)

- 1 In the **Electrical Circuit** toolbar, click  **Resistor**.
- 2 In the **Settings** window for **Resistor**, locate the **Node Connections** section.

3 In the table, enter the following settings:

Label	Node names
p	1
n	2

4 Locate the **Device Parameters** section. In the  $R$  text field, type  $R_g$ .

*Resistor 2 (R2)*

1 In the **Electrical Circuit** toolbar, click  **Resistor**.

2 In the **Settings** window for **Resistor**, locate the **Node Connections** section.

3 In the table, enter the following settings:

Label	Node names
p	2
n	3

4 Locate the **Device Parameters** section. In the  $R$  text field, type  $R_E$ .

*Inductor 1 (L1)*

1 In the **Electrical Circuit** toolbar, click  **Inductor**.

2 In the **Settings** window for **Inductor**, locate the **Node Connections** section.

3 In the table, enter the following settings:

Label	Node names
p	3
n	4

4 Locate the **Device Parameters** section. In the  $L$  text field, type  $L_E$ .

*Resistor 3 (R3)*

1 In the **Electrical Circuit** toolbar, click  **Resistor**.

2 In the **Settings** window for **Resistor**, locate the **Node Connections** section.

3 In the table, enter the following settings:

Label	Node names
p	3
n	4

4 Locate the **Device Parameters** section. In the  $R$  text field, type  $R_p_E$ .

### Voltage Source 2 (V2)

- 1 In the **Electrical Circuit** toolbar, click  **Voltage Source**.
- 2 In the **Settings** window for **Voltage Source**, locate the **Node Connections** section.
- 3 In the table, enter the following settings:

Label	Node names
p	4
n	0

- 4 Locate the **Device Parameters** section. In the  $v_{src}$  text field, type  $BL * 1ms . M1 . v$ .

### LUMPED MECHANICAL SYSTEM (LMS)

#### Spring 1 (K1)

- 1 In the **Physics** toolbar, click  **Global** and choose **Spring**.
- 2 In the **Settings** window for **Spring**, locate the **Node Connections** section.
- 3 In the table, enter the following settings:

Label	Node names
p1	0
p2	1

- 4 Locate the **Component Parameters** section. In the  $k$  text field, type  $1/C_{MS}$ .
- 5 Locate the **Results** section. Find the **Add the following to default results** subsection. Clear the **Displacement** checkbox.

#### Damper 1 (C1)

- 1 In the **Physics** toolbar, click  **Global** and choose **Damper**.
- 2 In the **Settings** window for **Damper**, locate the **Node Connections** section.
- 3 In the table, enter the following settings:

Label	Node names
p1	0
p2	1

- 4 Locate the **Component Parameters** section. In the  $c$  text field, type  $R_{MS}$ .
- 5 Locate the **Results** section. Find the **Add the following to default results** subsection. Clear the **Displacement** checkbox.

### Mass 1 (M1)

- 1 In the **Physics** toolbar, click  **Global** and choose **Mass**.
- 2 In the **Settings** window for **Mass**, locate the **Node Connections** section.
- 3 In the table, enter the following settings:

Label	Node names
p1	1
p2	2

- 4 Locate the **Component Parameters** section. In the  $m$  text field, type M\_MD.
- 5 Locate the **Results** section. Find the **Add the following to default results** subsection. Clear the **Displacement** checkbox.
- 6 Select the **Velocity** checkbox.

### Force Node 1 (frc1)

- 1 In the **Physics** toolbar, click  **Global** and choose **Force Node**.
- 2 In the **Settings** window for **Force Node**, locate the **Node Connections** section.
- 3 In the table, enter the following settings:

Label	Node name
p1	2

- 4 Locate the **Terminal Parameters** section. In the  $f_{p10}$  text field, type BL\*cir.R2.i+F\_D.

## MESH 1

Proceed and generate the mesh using the **Physics-controlled mesh** functionality. The frequency controlling the maximum element size is per default taken **From study**. Set the desired **Frequencies** in the study step. In general, 5 to 6 second-order elements per wavelength are needed to resolve the waves. For more details, see *Meshing (Resolving the Waves)* in the *Acoustics Module User's Guide*. In this model, use 8 elements per wavelength; the default **Automatic** is to have 5.

- 1 In the **Model Builder** window, under **Component 1 (comp1)** click **Mesh 1**.
- 2 In the **Settings** window for **Mesh**, locate the **Physics-Controlled Mesh** section.
- 3 In the table, clear the **Use** checkboxes for **Electrical Circuit (cir)** and **Lumped Mechanical System (lms)**.
- 4 Locate the **Pressure Acoustics, Frequency Domain (acpr)** section. From the **Number of mesh elements per wavelength** list, choose **User defined**.



5 In the text field, type 8.

Now, proceed to the study and set the frequencies, before building the mesh and solving.

## STUDY 1

### *Step 1: Frequency Domain*

1 In the **Model Builder** window, under **Study 1** click **Step 1: Frequency Domain**.

2 In the **Settings** window for **Frequency Domain**, locate the **Study Settings** section.

3 Click  **Range**.

4 In the **Range** dialog, choose **ISO preferred frequencies** from the **Entry method** list.

5 In the **Start frequency** text field, type 10.

6 In the **Stop frequency** text field, type 10000.

7 From the **Interval** list, choose **1/24 octave**.

8 Click **Replace**.

## MESH 1

In the **Model Builder** window, under **Component 1 (comp1)** right-click **Mesh 1** and choose **Build All**.

## STUDY 1

In the **Study** toolbar, click  **Compute**.

## RESULTS

### *Acoustic Pressure (acpr)*



First, look at the default plots. Investigate the 2D **Sound Pressure Level (acpr)** plot to verify the performance of the perfectly matched layer (PML). After doing this you can disable plotting in the PML region, which is unphysical. Secondly, look at the default exterior-field plots and make a few changes, before setting up a range of plots to investigate the loudspeaker driver performance.

### *Sound Pressure Level (acpr)*

Look at the sound pressure level (SPL) plots at the frequencies of 10 kHz, 1 kHz, and 10 Hz. Note that the SPL decreases nearly 100 dB over the width of the thickness of the PML. This means that the outgoing waves are extremely damped.

1 In the **Model Builder** window, click **Sound Pressure Level (acpr)**.

2 In the **Settings** window for **2D Plot Group**, locate the **Data** section.

- 3 From the **Parameter value (freq (Hz))** list, choose **1000**.
- 4 In the **Sound Pressure Level (acpr)** toolbar, click  **Plot**.
- 5 From the **Parameter value (freq (Hz))** list, choose **10**.
- 6 In the **Sound Pressure Level (acpr)** toolbar, click  **Plot**.



#### *Study 1/Solution 1 (sol1)*

In the **Model Builder** window, expand the **Results** > **Datasets** node, then click **Study 1/Solution 1 (sol1)**.

#### *Selection*

- 1 In the **Results** toolbar, click  **Attributes** and choose **Selection**.
- 2 In the **Settings** window for **Selection**, locate the **Geometric Entity Selection** section.
- 3 From the **Geometric entity level** list, choose **Domain**.
- 4 Select Domains 2 and 3 only.

#### *Acoustic Pressure (acpr)*

- 1 In the **Model Builder** window, under **Results** click **Acoustic Pressure (acpr)**.
- 2 In the **Settings** window for **2D Plot Group**, locate the **Data** section.
- 3 From the **Parameter value (freq (Hz))** list, choose **1000**.
- 4 In the **Acoustic Pressure (acpr)** toolbar, click  **Plot**.
- 5 Click the  **Zoom Extents** button in the **Graphics** toolbar.
- 6 From the **Parameter value (freq (Hz))** list, choose **5000**.
- 7 In the **Acoustic Pressure (acpr)** toolbar, click  **Plot**.

These two plots should reproduce [Figure 3](#).

#### *Radiation Pattern 1*

- 1 In the **Model Builder** window, expand the **Exterior-Field Sound Pressure Level (acpr)** node, then click **Radiation Pattern 1**.
- 2 In the **Settings** window for **Radiation Pattern**, locate the **Evaluation** section.
- 3 Find the **Angles** subsection. From the **Restriction** list, choose **Manual**.
- 4 In the  $\phi$  **start** text field, type -90.
- 5 In the  $\phi$  **range** text field, type 180.
- 6 In the **Exterior-Field Sound Pressure Level (acpr)** toolbar, click  **Plot**.



### *Radiation Pattern 1*

- 1 In the **Model Builder** window, expand the **Exterior-Field Pressure (acpr)** node, then click **Radiation Pattern 1**.
- 2 In the **Settings** window for **Radiation Pattern**, locate the **Evaluation** section.
- 3 Find the **Angles** subsection. From the **Restriction** list, choose **Manual**.
- 4 In the  $\phi$  **start** text field, type -90.
- 5 In the  $\phi$  **range** text field, type 180.
- 6 In the **Exterior-Field Pressure (acpr)** toolbar, click  **Plot**.



These two polar plots should reproduce [Figure 6](#).

Now modify the default plots of the **Lumped Mechanical System** interface to reproduce [Figure 5](#).

### *Mechanical Force, Amplitude*



- 1 In the **Model Builder** window, under **Results** click **Force, Amplitude (lms) 1**.
- 2 In the **Settings** window for **ID Plot Group**, type Mechanical Force, Amplitude in the **Label** text field.
- 3 Click to expand the **Title** section. From the **Title type** list, choose **Label**.
- 4 Locate the **Plot Settings** section. In the **y-axis label** text field, type Force (N).
- 5 Locate the **Legend** section. From the **Position** list, choose **Upper left**.
- 6 Click the  **x-Axis Log Scale** button in the **Graphics** toolbar.
- 7 In the **Mechanical Force, Amplitude** toolbar, click  **Plot**.

### *Mechanical Force, Phase*



- 1 In the **Model Builder** window, under **Results** click **Force, Phase (lms) 1**.
- 2 In the **Settings** window for **ID Plot Group**, type Mechanical Force, Phase in the **Label** text field.
- 3 Locate the **Title** section. From the **Title type** list, choose **Label**.
- 4 Locate the **Plot Settings** section. In the **y-axis label** text field, type Phase (rad).
- 5 Locate the **Legend** section. From the **Position** list, choose **Lower right**.
- 6 Click the  **x-Axis Log Scale** button in the **Graphics** toolbar.
- 7 In the **Mechanical Force, Phase** toolbar, click  **Plot**.

### *Diaphragm Velocity, Amplitude*

- 1 In the **Model Builder** window, under **Results** click **Velocity, Amplitude (MI)**.

- 2 In the **Settings** window for **ID Plot Group**, type Diaphragm Velocity, Amplitude in the **Label** text field.
- 3 Locate the **Title** section. From the **Title type** list, choose **Label**.
- 4 Locate the **Plot Settings** section. In the **y-axis label** text field, type Velocity (m/s).
- 5 Click the  **x-Axis Log Scale** button in the **Graphics** toolbar.
- 6 In the **Diaphragm Velocity, Amplitude** toolbar, click  **Plot**.



#### *Diaphragm Velocity, Phase*

- 1 In the **Model Builder** window, under **Results** click **Velocity, Phase (M1)**.
- 2 In the **Settings** window for **ID Plot Group**, type Diaphragm Velocity, Phase in the **Label** text field.
- 3 Locate the **Title** section. From the **Title type** list, choose **Label**.
- 4 Locate the **Plot Settings** section. In the **y-axis label** text field, type Phase (rad).
- 5 Click the  **x-Axis Log Scale** button in the **Graphics** toolbar.
- 6 In the **Diaphragm Velocity, Phase** toolbar, click  **Plot**.

#### *Acoustic Radiated Power*

- 1 In the **Results** toolbar, click  **ID Plot Group**.
- 2 In the **Settings** window for **ID Plot Group**, type Acoustic Radiated Power in the **Label** text field.
- 3 Locate the **Title** section. From the **Title type** list, choose **Label**.
- 4 Locate the **Plot Settings** section.
- 5 Select the **x-axis label** checkbox. In the associated text field, type  $f$  (Hz).
- 6 Select the **y-axis label** checkbox. In the associated text field, type Power (W).
- 7 Locate the **Legend** section. From the **Position** list, choose **Lower middle**.

#### *Global I*



- 1 Right-click **Acoustic Radiated Power** and choose **Global**.
- 2 In the **Settings** window for **Global**, click **Replace Expression** in the upper-right corner of the **y-Axis Data** section. From the menu, choose **Component I (comp1) > Definitions > Variables > P\_AR - Radiated power - W**.
- 3 In the **Acoustic Radiated Power** toolbar, click  **Plot**.
- 4 Click the  **x-Axis Log Scale** button in the **Graphics** toolbar.

This plot should reproduce [Figure 4](#) (top left).

### Electric Input Power

- 1 In the **Results** toolbar, click  **ID Plot Group**.
- 2 In the **Settings** window for **ID Plot Group**, type Electric Input Power in the **Label** text field.
- 3 Locate the **Title** section. From the **Title type** list, choose **Label**.
- 4 Locate the **Plot Settings** section.
- 5 Select the **x-axis label** checkbox. In the associated text field, type  $f$  (Hz).
- 6 Select the **y-axis label** checkbox. In the associated text field, type Power (W).
- 7 Locate the **Legend** section. From the **Position** list, choose **Lower right**.

### Global I

- 1 Right-click **Electric Input Power** and choose **Global**.
- 2 In the **Settings** window for **Global**, click **Replace Expression** in the upper-right corner of the **y-Axis Data** section. From the menu, choose **Component I (comp I) > Definitions > Variables > P\_E - Electric input power (rms) - W**.
- 3 In the **Electric Input Power** toolbar, click  **Plot**.
- 4 Click the  **x-Axis Log Scale** button in the **Graphics** toolbar.  
This plot should reproduce [Figure 4](#) (top right).



### Driver Efficiency

- 1 In the **Results** toolbar, click  **ID Plot Group**.
- 2 In the **Settings** window for **ID Plot Group**, type Driver Efficiency in the **Label** text field.
- 3 Locate the **Title** section. From the **Title type** list, choose **Label**.
- 4 Locate the **Plot Settings** section.
- 5 Select the **x-axis label** checkbox. In the associated text field, type  $f$  (Hz).
- 6 Select the **y-axis label** checkbox. In the associated text field, type Efficiency (%).

### Global I

- 1 Right-click **Driver Efficiency** and choose **Global**.
- 2 In the **Settings** window for **Global**, locate the **y-Axis Data** section.
- 3 In the table, enter the following settings:

Expression	Unit	Description
eta*100	1	Driver efficiency

- 4 In the **Driver Efficiency** toolbar, click  **Plot**.
- 5 Click the  **x-Axis Log Scale** button in the **Graphics** toolbar.  
This plot should reproduce [Figure 4](#) (bottom left).  
Set up a parametric curve used to evaluate the exterior field outside of the computational mesh.

#### *Parametric Curve 2D 1*

- 1 In the **Results** toolbar, click  **More Datasets** and choose **Parametric Curve 2D**.
- 2 In the **Settings** window for **Parametric Curve 2D**, locate the **Expressions** section.
- 3 In the **z** text field, type  $s*5[m]+(1-s)*Rair$ .
- 4 Select the **Only evaluate globally defined expressions** checkbox.

#### *On-axis Pressure Field*

- 1 In the **Results** toolbar, click  **ID Plot Group**.
- 2 In the **Settings** window for **ID Plot Group**, type On-axis Pressure Field in the **Label** text field.
- 3 Locate the **Data** section. From the **Dataset** list, choose **Parametric Curve 2D 1**.
- 4 Locate the **Title** section. From the **Title type** list, choose **Label**.
- 5 Locate the **Plot Settings** section.
- 6 Select the **x-axis label** checkbox. In the associated text field, type  $z$  (m).
- 7 Select the **y-axis label** checkbox. In the associated text field, type Pressure (Pa).
- 8 Locate the **Data** section. From the **Parameter selection (freq)** list, choose **From list**.
- 9 In the **Parameter values (freq (Hz))** list, select **1000**.
- 10 Locate the **Legend** section. Clear the **Show legends** checkbox.

#### *Line Graph 1*

- 1 Right-click **On-axis Pressure Field** and choose **Line Graph**.
- 2 Select Boundary 4 only.
- 3 In the **Settings** window for **Line Graph**, locate the **y-Axis Data** section.
- 4 In the **Expression** text field, type  $p_{ext}(r, z)$ .
- 5 Locate the **x-Axis Data** section. From the **Parameter** list, choose **Expression**.
- 6 In the **Expression** text field, type  $z$ .
- 7 Click to expand the **Quality** section. From the **Resolution** list, choose **Extra fine**.

8 In the **On-axis Pressure Field** toolbar, click  **Plot**.

This plot should reproduce [Figure 4](#) (bottom right).

Create a 2D intensity plot that includes the magnitude of the intensity vector  $acpr.I_{rms}$  as well as an arrow surface (vector field plot) of the intensity vector, with the components ( $acpr.I_r, acpr.I_z$ ).

#### *Intensity*

1 In the **Results** toolbar, click  **2D Plot Group**.

2 In the **Settings** window for **2D Plot Group**, type **Intensity** in the **Label** text field.

#### *Surface 1*

1 Right-click **Intensity** and choose **Surface**.

2 In the **Settings** window for **Surface**, locate the **Expression** section.

3 In the **Expression** text field, type  $acpr.I_{rms}$ .

#### *Arrow Surface 1*

1 In the **Model Builder** window, right-click **Intensity** and choose **Arrow Surface**.

2 In the **Settings** window for **Arrow Surface**, click **Replace Expression** in the upper-right corner of the **Expression** section. From the menu, choose **Component 1 (comp1) > Pressure Acoustics, Frequency Domain > Intensity >  $acpr.I_r, acpr.I_z$  - Intensity**.

3 Locate the **Coloring and Style** section. From the **Color** list, choose **Black**.

#### *Arrow Line 1*

1 Right-click **Intensity** and choose **Arrow Line**.

2 In the **Settings** window for **Arrow Line**, click **Replace Expression** in the upper-right corner of the **Expression** section. From the menu, choose **Component 1 (comp1) > Pressure Acoustics, Frequency Domain > Geometry >  $acpr.nr, acpr.nz$  - Normal vector**.

3 Locate the **Coloring and Style** section. From the **Color** list, choose **Black**.

4 In the **Intensity** toolbar, click  **Plot**.

5 Click the  **Zoom Extents** button in the **Graphics** toolbar.



Now change the evaluation frequency to 5000 Hz, 1000 Hz, and 100 Hz in order to plot and reproduce [Figure 7](#).

#### *Intensity*

1 In the **Model Builder** window, click **Intensity**.

2 In the **Settings** window for **2D Plot Group**, locate the **Data** section.

3 From the **Parameter value (freq (Hz))** list, choose **5000**.



- 4 In the **Intensity** toolbar, click  **Plot**.
- 5 From the **Parameter value (freq (Hz))** list, choose **1000**.
- 6 In the **Intensity** toolbar, click  **Plot**.
- 7 From the **Parameter value (freq (Hz))** list, choose **100**.
- 8 In the **Intensity** toolbar, click  **Plot**.

Next create the directivity plot of the speaker.

#### *Directivity*

- 1 In the **Results** toolbar, click  **ID Plot Group**.
- 2 In the **Settings** window for **ID Plot Group**, type **Directivity** in the **Label** text field.

#### *Directivity 1*

- 1 In the **Directivity** toolbar, click  **More Plots** and choose **Directivity**.
- 2 In the **Settings** window for **Directivity**, locate the **Evaluation** section.
- 3 Find the **Angles** subsection. From the **Restriction** list, choose **Manual**.
- 4 In the  $\phi$  **start** text field, type **-90**.
- 5 In the  $\phi$  **range** text field, type **180**.
- 6 Click to expand the **Coloring and Style** section. From the **Layout** list, choose **Frequency on y-axis**.
- 7 In the **Directivity** toolbar, click  **Plot**.
- 8 Click the  **y-Axis Log Scale** button in the **Graphics** toolbar.

This should reproduce the directivity plot depicted in [Figure 7](#). You can tailor the plot to your needs using the normalization options or defining the specific levels to use in the contour plot.